

Technical Data Sheet

Infrared MIDLED LED

HIR89-01C/1R

Features

- Low forward voltage.
- View angle 30° (Typ.)
- Pb free
- The product itself will remain within RoHS compliant version.
- Compatible with infrared and vapor phase reflow solder process
- Taping as Top view.



Descriptions

- HIR89-01C/1R is an infrared emitting diode with miniature MIDLED package.
The device is spectrally matched with silicon photodiode and phototransistor.

Applications

- Infrared applied system

Device Selection Guide

LED Part No.	Chip	Lens Color
	Material	
HIR89-01C/1R	GaAlAs	Water clear

HIR89-01C/1R

Package Dimensions

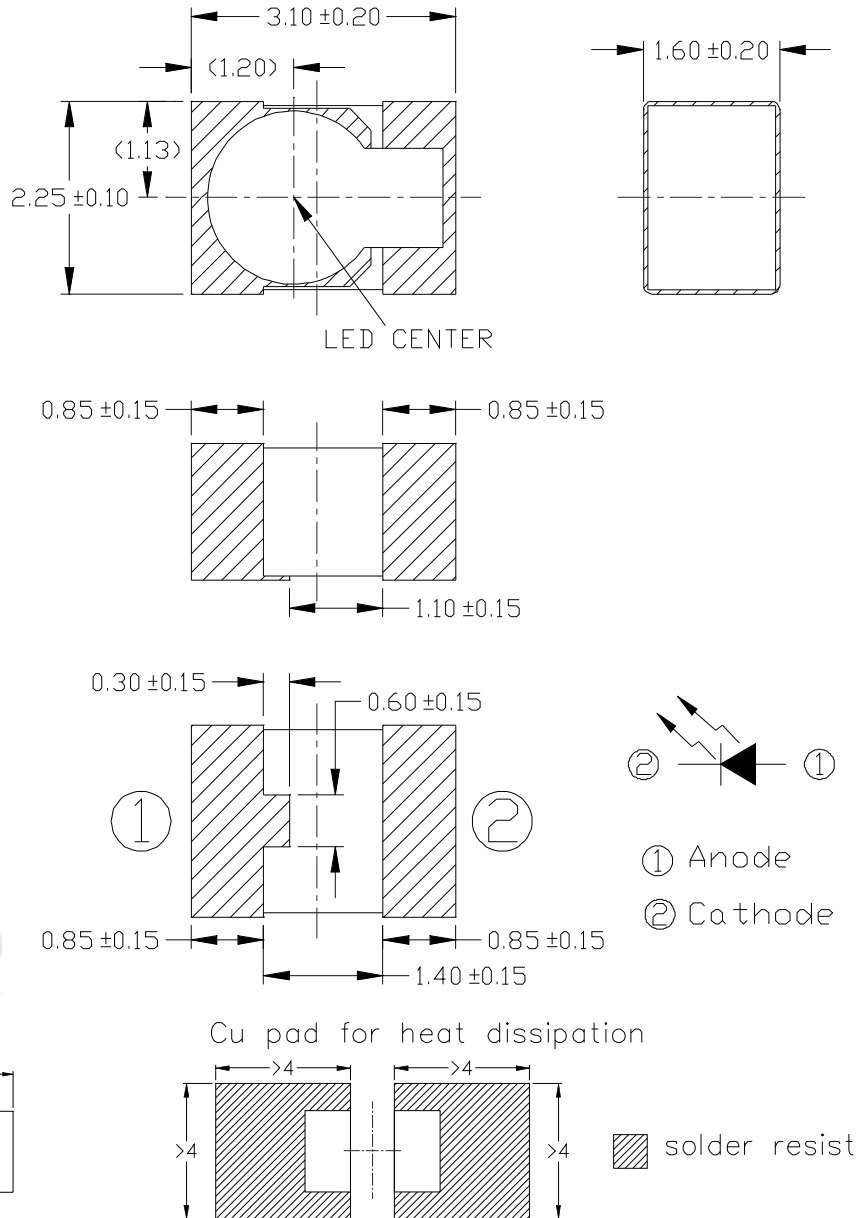

soldering pattern for top looker

- Notes:**
- 1.All dimensions are in millimeters
 - 2.Tolerances unless dimensions $\pm 0.1\text{mm}$

Absolute Maximum Ratings (Ta=25)

Parameter	Symbol	Rating	Units
Continuous Forward Current	I _F	65	mA
Peak Forward Current *1	I _{FP}	200	mA
Reverse Voltage	V _R	5	V
Operating Temperature	T _{opr}	-40~ +85	
Storage Temperature	T _{stg}	-40 ~ +100	
Soldering Temperature *2	T _{sol}	260	
Power Dissipation at(or below) 25 Free Air Temperature	P _d	100	mW

Notes: *1:I_{FP} Conditions--Pulse Width 500 μ s and Duty 5%.

*2:Soldering time 5 seconds.

Electro-Optical Characteristics (Ta=25)

Parameter	Symbol	Condition	Min.	Typ.	Max.	Unit
Radiant Intensity	I _E	I _F =70mA ,tp=20ms	25	--	125	mW/sr
Peak Wavelength	λ	I _F =100mA	840	850	870	nm
Spectral Bandwidth		I _F =100mA	--	30	--	nm
Forward Voltage	V _F	I _F =20mA	--	1.40	1.70	V
		I _F =70mA,tp=20ms	--	1.55	1.90	
Reverse Current	I _R	V _R =5V	--	--	10	μ A
Rise time	t _r	I _F =20mA	--	16	--	ns
Fall time	t _f	I _F =20mA	--	30	--	ns
View Angle	2 1/2	I _F =20mA	--	30	--	deg

Rank

Condition : I_F=70mA

Unit : mW/sr

Bin Number	B	C	D
Min	25	40	63
Max	50	80	125

Typical Electro-Optical Characteristics Curves

Fig.1 Forward Current vs. Ambient Temperature

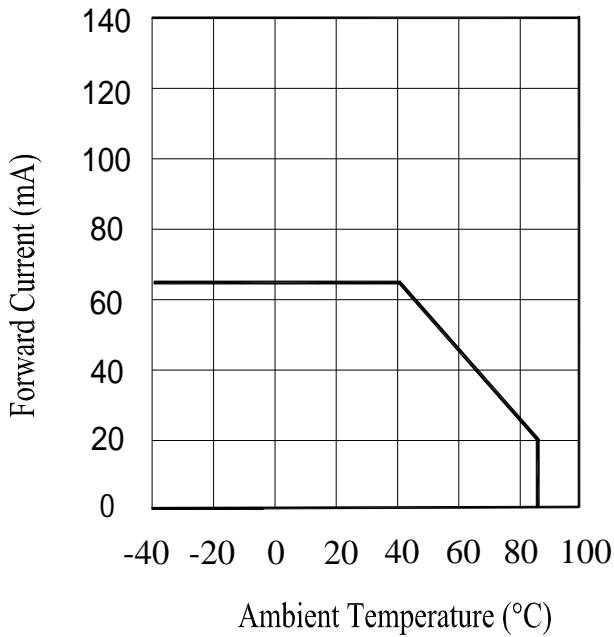

Fig.2 Spectral Distribution

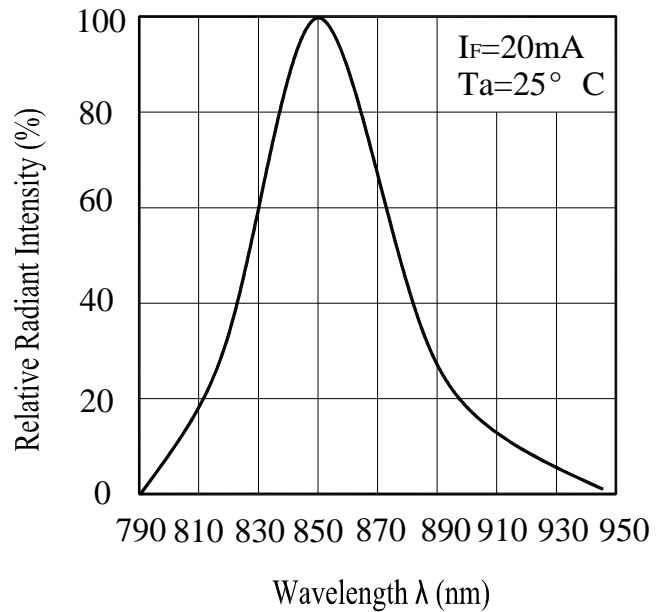

Fig.3 Peak Emission Wavelength vs. Ambient Temperature

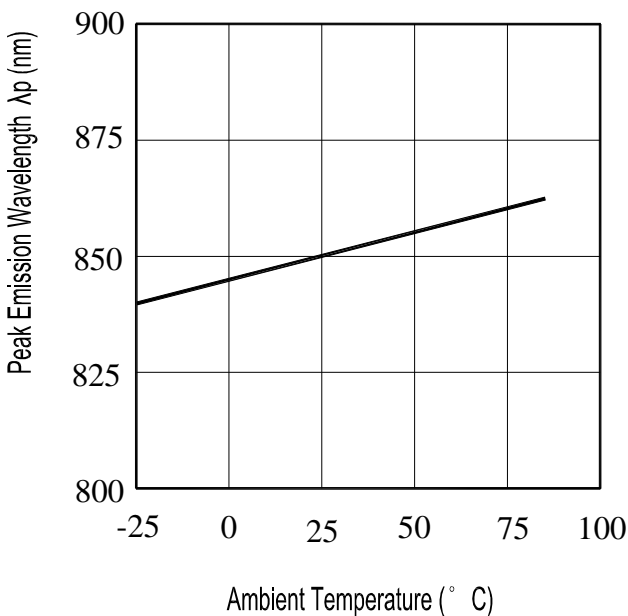
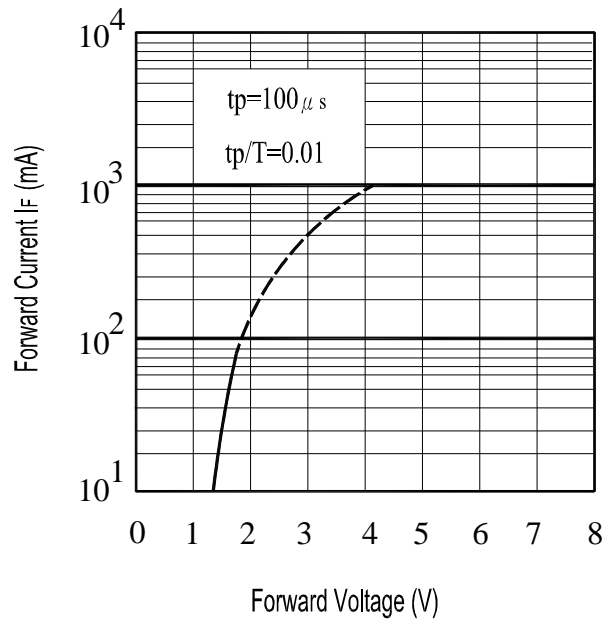

Fig.4 Forward Current vs. Forward Voltage



Typical Electro-Optical Characteristics Curves

Fig.5 Relative Intensity vs.
Forward Current

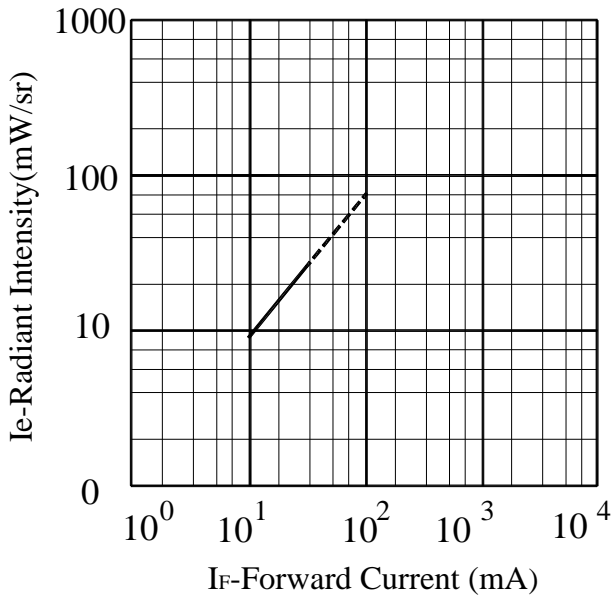
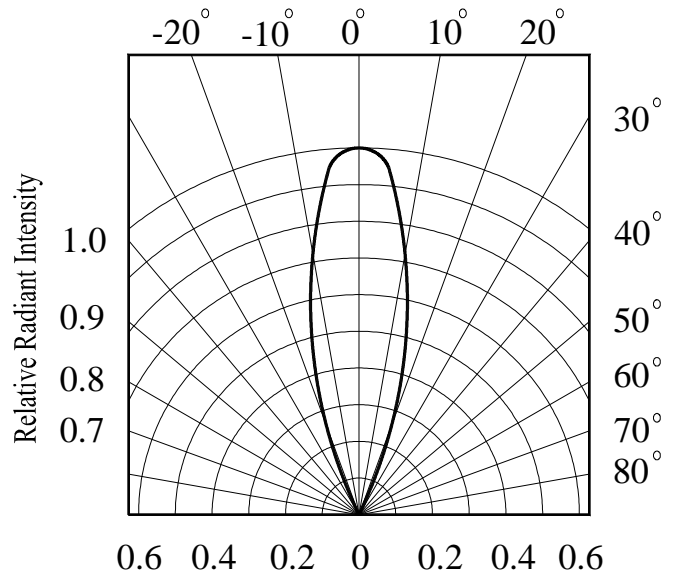

Fig.6 Relative Radiant Intensity vs.
Angular Displacement



EVERLIGHT

Precautions For Use

1. Over-current-proof

Customer must apply resistors for protection , otherwise slight voltage shift will cause big current change (Burn out will happen).

2. Storage

2.1 Do not open moisture proof bag before devices are ready to use.

2.2 Shelf life in sealed bag from the bag seal date:

18 months at 10°C~30°C and < 90% RH.

2.3 After opening the package, the devices must be stored at 10°C~30°C and ≤ 60%RH, and used within 72 hours(floor life).

2.4 If the moisture absorbent material(desiccant material) has faded or unopened bag has exceeded the shelf life or devices(out of bag) have exceeded the floor life, baking treatment is required.

2.5 If baking is required, refer to IPC/JEDEC J-STD-033 for bake procedure or recommend the following conditions :

192 hours at 40°C +5/-0°C and < 5 % RH (reeled/tubed/loose units) or

96 hours at 60°C ± 5°C and < 5 % RH (reeled/tubed/loose units) or

24 hours at 125°C ± 5°C, not suitable for reel or tubes.

3. Soldering Condition

3.1 Pb-free solder temperature profile

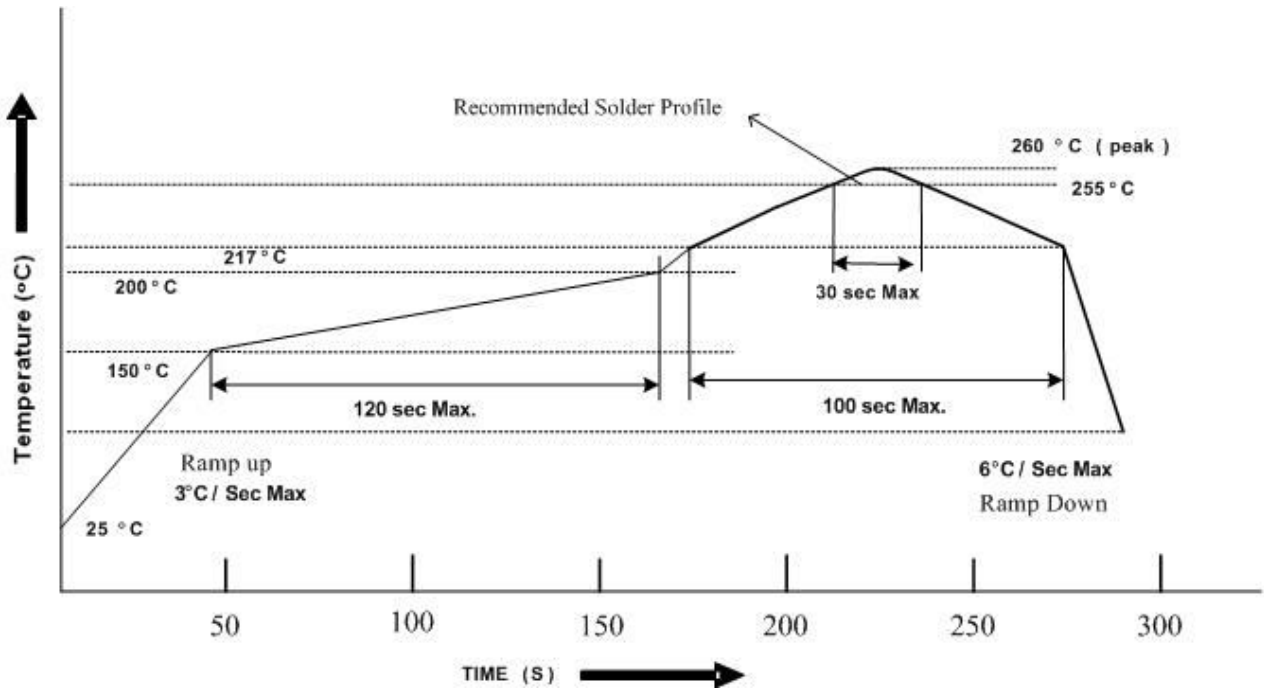

3.2 Reflow soldering should not be done more than two times.

3.3 When soldering, do not put stress on the LEDs during heating.

3.4 After soldering, do not warp the circuit board.

4.Soldering Iron

Each terminal is to go to the tip of soldering iron temperature less than 350 for 3 seconds within once in less than the soldering iron capacity 25W. Leave two seconds and more intervals, and do soldering of each terminal. Be careful because the damage of the product is often started at the time of the hand solder.

5.Repairing

Repair should not be done after the LEDs have been soldered. When repairing is unavoidable, a double-head soldering iron should be used (as below figure). It should be confirmed beforehand whether the characteristics of the LEDs will or will not be damaged by repairing.

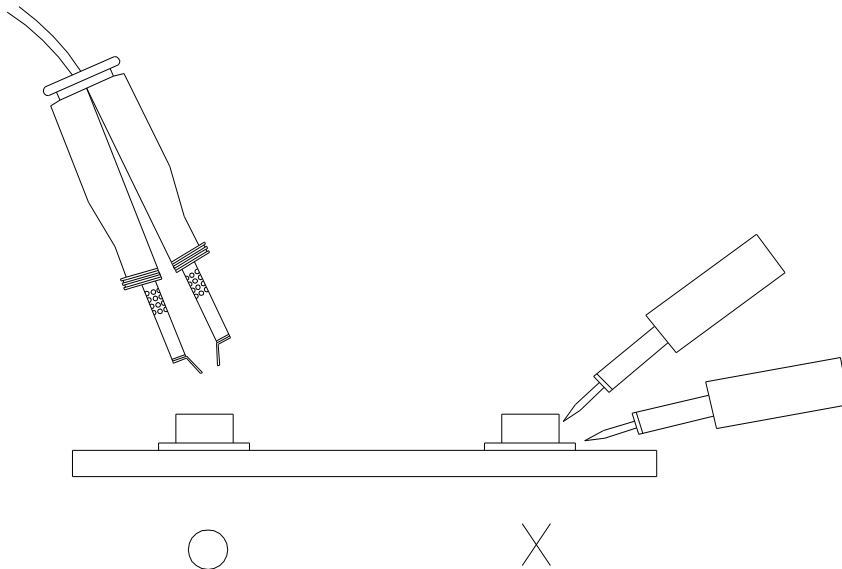

Packing Procedure

HIR89-01C/1R

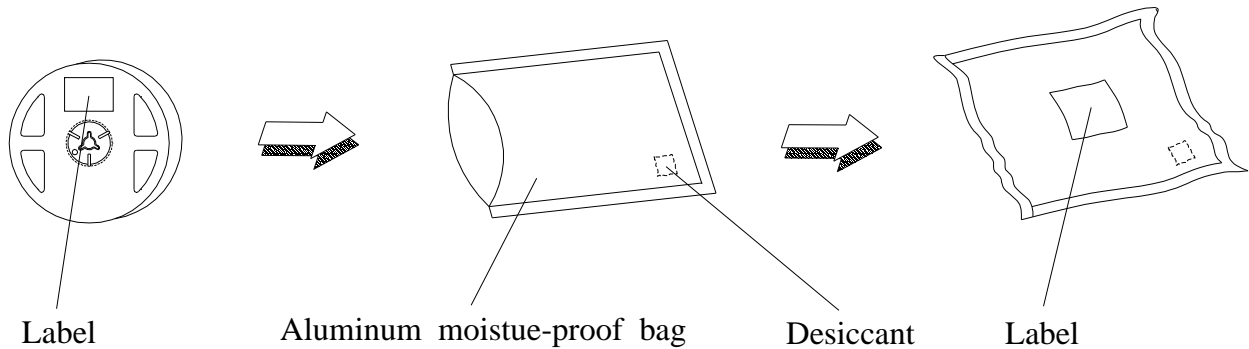

Label Form Specification



The label form contains the following fields and markings: EVERLIGHT logo, RoHS symbol, CPN: P/N (with barcode), QTY: (with barcode), LOT NO: (with barcode), Reference: (with barcode), CAT: (with field), HUE: (with field), REF: (with field), and MADE IN TAIWAN at the bottom.

CPN: Customer's Production Number
P/N : Production Number
QTY: Packing Quantity
CAT: Ranks
HUE: Peak Wavelength
REF: Reference
LOT No: Lot Number
MADE IN TAIWAN: Production Place

Notes

1. Above specification may be changed without notice. EVERLIGHT will reserve authority on material change for above specification.
2. When using this product, please observe the absolute maximum ratings and the instructions for using outlined in these specification sheets. EVERLIGHT assumes no responsibility for any damage resulting from use of the product which does not comply with the absolute maximum ratings and the instructions included in these specification sheets.
3. These specification sheets include materials protected under copyright of EVERLIGHT corporation. Please don't reproduce or cause anyone to reproduce them without EVERLIGHT's consent.

EVERLIGHT ELECTRONICS CO., LTD.
Office: No 25, Lane 76, Sec 3, Chung Yang Rd,
Tucheng, Taipei 236, Taiwan, R.O.C

Tel: 886-2-2267-2000, 2267-9936
Fax: 886-2267-6244, 2267-6189, 2267-6306
<http://www.everlight.com>