



LOGIC
TECHNOLOGIES

PRODUCT SPECIFICATION

DESCRIPTION

TFT Module – 4.3” HVGA
480 x (RGB) x 272
Full viewing angle High brightness
With resistive touch panel

PART NUMBER

LT180408-043RP

VERSION

1.0

ROHS COMPLIANT

Table of Contents

- GENERAL INFORMATION
- MECHANICAL DIMENSIONS
- ABSOLUTE MAXIMUM RATINGS
- ELECTRICAL CHARACTERISTICS
- BACKLIGHT CHARACTERISTICS
- ELECTRO-OPTICAL CHARACTERISTICS
- INTERFACE DESCRIPTION
- BLOCK DIAGRAM
- TIMING CHARACTERISTICS
- TIMING CHART & DATA
- TOUCH PANEL CHARACTERISTICS

- GENERAL INFORMATION

Item	Contents	Unit
LCD Type	TFT Transmissive, anti-glare	/
Technology	a-Si TFT	-
Viewing Direction	Full View	O'clock
Viewing Angle (Gray Scale Inversion Direction)	6:00	O'clock
Module dimensions (W x H x T)	105.5x 67.2 x 8.9(Max)	mm
Active area (W x H)	95.04 x 53.86	mm
Number of pixels	480 x 3 (RGB) x 272	/
Pixel pitch (W x H)	0.198 x 0.198	mm ²
Colours	16.7M	/
Contrast ratio	500 (typical)	/
Backlight	LED (10 in serial)	/
Backlight Brightness	500(typical)	cd/m ²
Interface	RGB 24bit + TCON	/
Touch solution	With Resisitive Touch	/
Touch driver	NA	/
Touch Interface	Resistive touch terminal	/
Operating temperature	-20 to +70	°C
Storage temperature	-30 to +80	°C

MECHANICAL DIMENSIONS

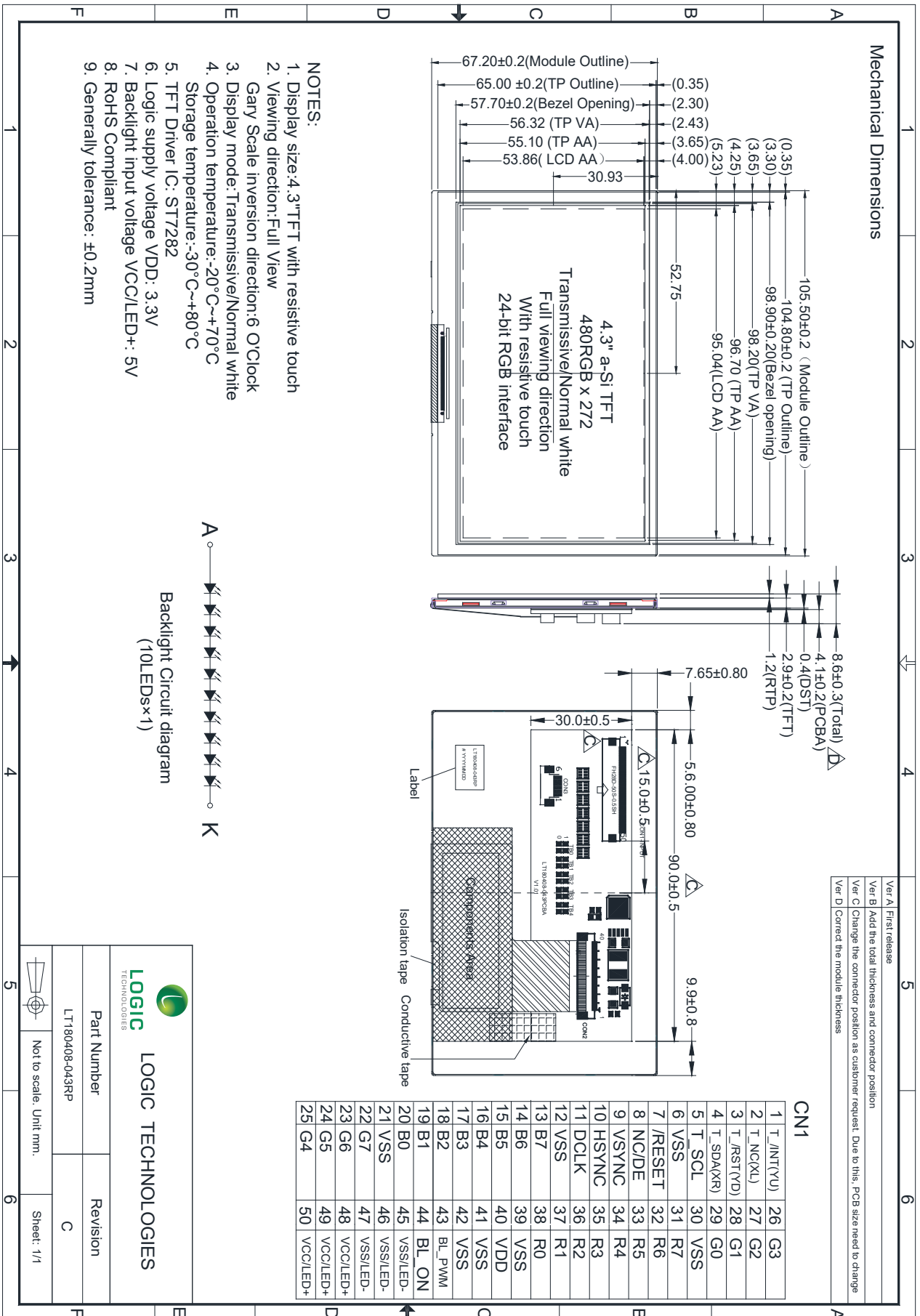

- ABSOLUTE MAXIMUM RATING

Parameter	Symbol	Min.	Max.	Unit	Note
Power Voltage	VDD	- 0.5	4.0	V	---
Backlight LED Forward Current	I _F	---	25	mA	One LED
Operating Temperature	T _{OPR}	- 20	70	°C	---
Storage temperature	T _{ST}	- 30	80	°C	---

- ELECTRICAL CHARACTERISTICS

Parameter	Symbol	Min	Typ.	Max	Unit	Note
Supply Voltage	V _{DD}	3.0	3.3	3.6	V	
Input Signal Voltage	Low Level	V _{IL}	0	---	0.2xVDD	Note1
	High Level	V _{IH}	0.8xVDD	---	VDD	
Output Signal Voltage	Low Level	V _{OL}	0	---	0.2xVDD	
	High Level	V _{OH}	0.8xVDD	---	VDD	
Power Consumption (TFT panel only)	Black Mode (60Hz)	---	75	135	mW	

Note 1: Signals include R0~R7, G0~G7, B0~B7, CLKIN, STBYB, Hsync, Vsync, DE

- BACKLIGHT CHARACTERISTICS

Item	Symbol	Min.	Typ.	Max.	Unit	Condition
Driver Input Voltage	VCC/LED+	---	5	6	V	
Current of driver IC	I _{VLED}	---	172	256	mA	
Power Consumption	P _{BL}	---	860	1536	mW	
PWM Frequency	PWM	100	150	200	Hz	10 series LEDs
Forward Current	I _F	---	20	25	mA	
Forward Current Voltage	V _F	---	31	35	V	
LED Lifetime	---	30k	---	---	Hrs	

NOTES

Backlight drive conditions : constant current driving method.

- The LED driving condition is defined for total backlight consumption.
- Forward Voltage adjustment depends on the Forward Current setting.
- One LED : max $I_F = 25\text{mA}$, $V_F = 3.2\text{V}$
- I_F is defined for one channel LED.
- If the LEDs are driven by high current, high ambient temperature & humidity condition the lifetime of the LEDs will be reduced.
- Operating life means brightness reduces to 50% of initial brightness.
- Typical operating life time is estimated data.
- Backlight Connection Internal Diagram



- ELECTRO-OPTICAL CHARACTERISTICS

Item	Symbol	Condition	Min.	Typ.	Max.	Unit	Refer	Note	
Response Time	T_{ON}	25°C	---	20	30	ms	Fig 1	1	
	T_{OFF}								
Contrast ratio	Cr	$\theta=0^\circ$	---	500	---	---	Fig 2	1	
Uniformity	U	---	---	75	---	%	Fig 2	3	
NTSC	---	---	---	50	---	%			
Surface Luminance	Lv		400	500	---	cd/m ²	Fig 2	2	
Viewing angle ratio	Cr=10	$\varnothing=\text{Top}$	60	75	---	deg	Fig 3	6	
		$\varnothing=\text{Bottom}$	60	75	---				
		$\varnothing=\text{Left}$	60	75	---				
		$\varnothing=\text{Right}$	60	75	---				
CIE (x,y) chromaticity	Red	x	Backlight On	0.559	0.609	0.659	---	Fig 2.	5
		y		0.305	0.355	0.405			
	Green	x		0.277	0.315	0.364			
		y		0.505	0.555	0.605			
	Blue	x		0.089	0.136	0.189			
		y		0.089	0.139	0.189			
	White	x		0.254	0.304	0.354			
		y		0.294	0.344	0.394			

Note

1. Contrast ratio (CR) is defined mathematically in Figure 2.

$$\text{Contrast Ratio} = \frac{\text{Average Surface Luminance with all white pixels (P1, P2, P3, P4, P5)}}{\text{Average Surface Luminance with all black pixels (P1, P2, P3, P4, P5)}}$$

Note 2. Surface luminance is the LCD surface from the surface with all pixels displaying white. For more information see figure 2.

$$L_v = \text{Average Surface Luminance with all white pixels (P1, P2, P3, P4, P5...)}$$

Note 3. Uniformity of surface luminance, White, is defined mathematically in figure 2.

$$\text{White} = \frac{\text{Minimum Surface Luminance with all white pixels (P1, P2, P3, P4, P5)}}{\text{Maximum Surface Luminance with all white pixels (P1, P2, P3, P4, P5)}}$$

Note 4. Response time is the time required for the display to transition from white to black (rise time T_r) and from black to white (decay or fall time, T_f). The industry standard test equipment used is the Autronic-Melcher's Conoscope.

Note 5. CIE (x,y) chromaticity. The x,y value is determined by measuring luminance at each test position 1 through 5, then calculating the average value.

Note 6. The Viewing angle is the angle at which the contrast ratio is greater than 2. For a TFT module, the contrast ratio is greater than 10. The angles are determined for the horizontal or 'x' axis and the vertical or 'y' axis with respect to the 'z' axis, being the LCD surface reference. Also see figure 3.

Note 7. For viewing angle and response time testing, the testing data is based on Autronic-Melcher's BM-7A. For the contrast ratio, surface luminance, luminance uniformity and chromaticity (CIE), the test data is based on the industry's standard SR-3A photo detector.

Note 8. For TFT modules, grey scale reversing occurs in the direction of the panel viewing angle.

Figure 1. Definition of response time

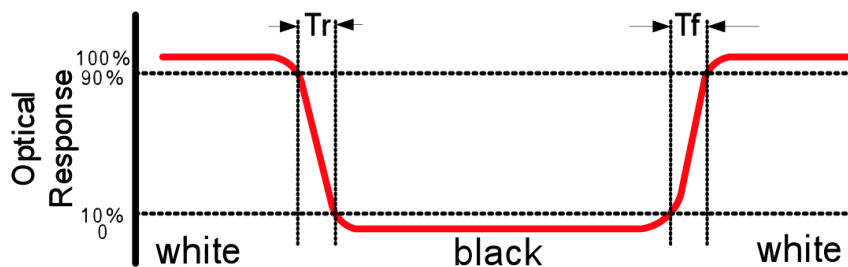

Figure 2. Measuring contrast ratio, surface luminance, luminance uniformity and CIE (chromaticity.)

A : 5mm, B : 5mm, H, V : Active area, Light spot size: dir=5mm, distance from the LCD surface to the detector lens 500mm. Measurement instrument is Topcon's luminance meter BM-5.

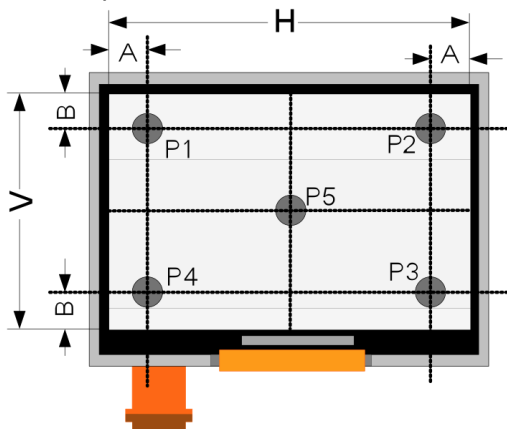
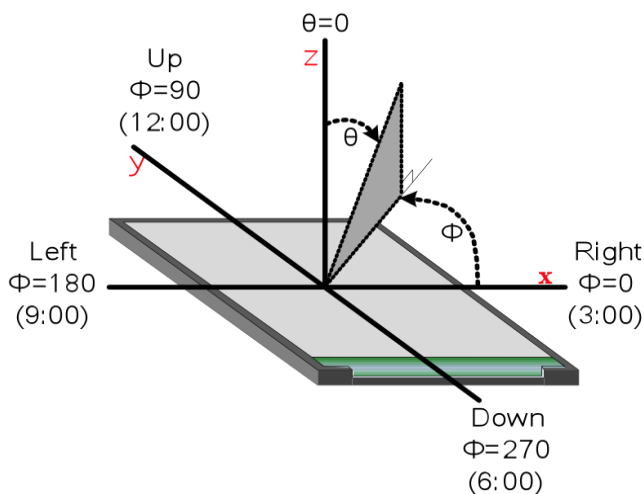

Figure 3. Definition of viewing angle



- INTERFACE DESCRIPTION

Pin	Symbol	I/O	Description	Note
1	T_/INT(YU)	I/O	Cap touch wake up /Interrupt; Resistive touch YU terminal; NC when no touch.	
2	T_NC(XL)	I/O	Resistive touch XU terminal; NC when with cap touch or no touch.	
3	T_/RST(YD)	I/O	Cap touch /Reset pin; Resistive touch YD terminal; NC when no touch.	
4	T_SDA(XR)	I/O	Cap touch I2C data input/output pin; Resistive touch XR terminal; NC when no touch.	
5	T_SCL	I	Cap touch I2C clock input pin; NC when with resistive touch or no touch.	
6	VSS	P	TFT&CTP Ground	
7	/RESET	I	TFT display system reset	
8	NC/DE	I	NC	Note1
9	VSYNC	I	Vertical Synch Input	
10	HSYNC	I	Horizontal Synch Signal	
11	DCLK	I	Display Pixel Clock	
12	VSS	I	TFT&CTP Ground	
13	B7	I	Blue data signal (MSB)	
14	B6	I	Blue data signal	
15	B5	I	Blue data signal	
16	B4	I	Blue data signal	
17	B3	I	Blue data signal	
18	B2	I	Blue data signal	
19	B1	I	Blue data signal	
20	B0	I	Blue data signal (LSB)	
21	VSS	P	TFT&CTP Ground	
22	G7	I	Green data signal (MSB)	
23	G6	I	Green data signal	
24	G5	I	Green data signal	
25	G4	I	Green data signal	
26	G3	I	Green data signal	
27	G2	I	Green data signal	

28	G1	I	Green data signal	
29	G0	I	Green data signal (LSB)	
30	VSS	P	TFT&CTP Ground	
31	R7	I	Red data signal (MSB)	
32	R6	I	Red data signal	
33	R5	I	Red data signal	
34	R4	I	Red data signal	
35	R3	I	Red data signal	
36	R2	I	Red data signal	
37	R1	I	Red data signal	
38	R0	I	Red data signal (LSB)	
39	VSS	P	TFT&CTP Ground	
40	VDD	P	TFT&CTP Power supply, 3.3V	
41	VSS	P	TFT&CTP Ground	
42	VSS	P	TFT&CTP Ground	
43	BL_PWM	I	PWM signal to control backlight diming. 100~200Hz	
44	BL_ON	I	Backlight on/off control pin. H: On ; L: Off	
45	VSS/LED-	P	Backlight Ground which is LED Cathode. R19=0ohm to connect it to TFT&CTP Ground	
46	VSS/LED-	P		
47	VSS/LED-	P		
48	VCC/LED+	P	Backlight supply voltage input, 5V typical	
49	VCC/LED+	P		
50	VCC/LED+	P		

I -Input only; O -Output only; I/O -Input /output; P -Power or Ground.

Suggested connection for this connector is 0.5pitch 50pins FFC or FPC.

Note 1: Note: Default mode is SYNC-DE mode. According ST7282 IC full spec, it support SYNC-DE mode timing. But after confirm with Sitronix FAE, they back that if only SYNC mode signals, that without DE enable data signal, also ok. So, it supports both SYNC mode and DE mode.

Note 2: When input 18 bits RGB data, the two low bits of R,G and B data must be grounded.

Note 3: Data shall be latched at the rasing edge of DCLK.

Note 4: Global reset pin, low active. Suggest it connect with an RC reset circuit for stability. Normally pull high.

Block Diagram

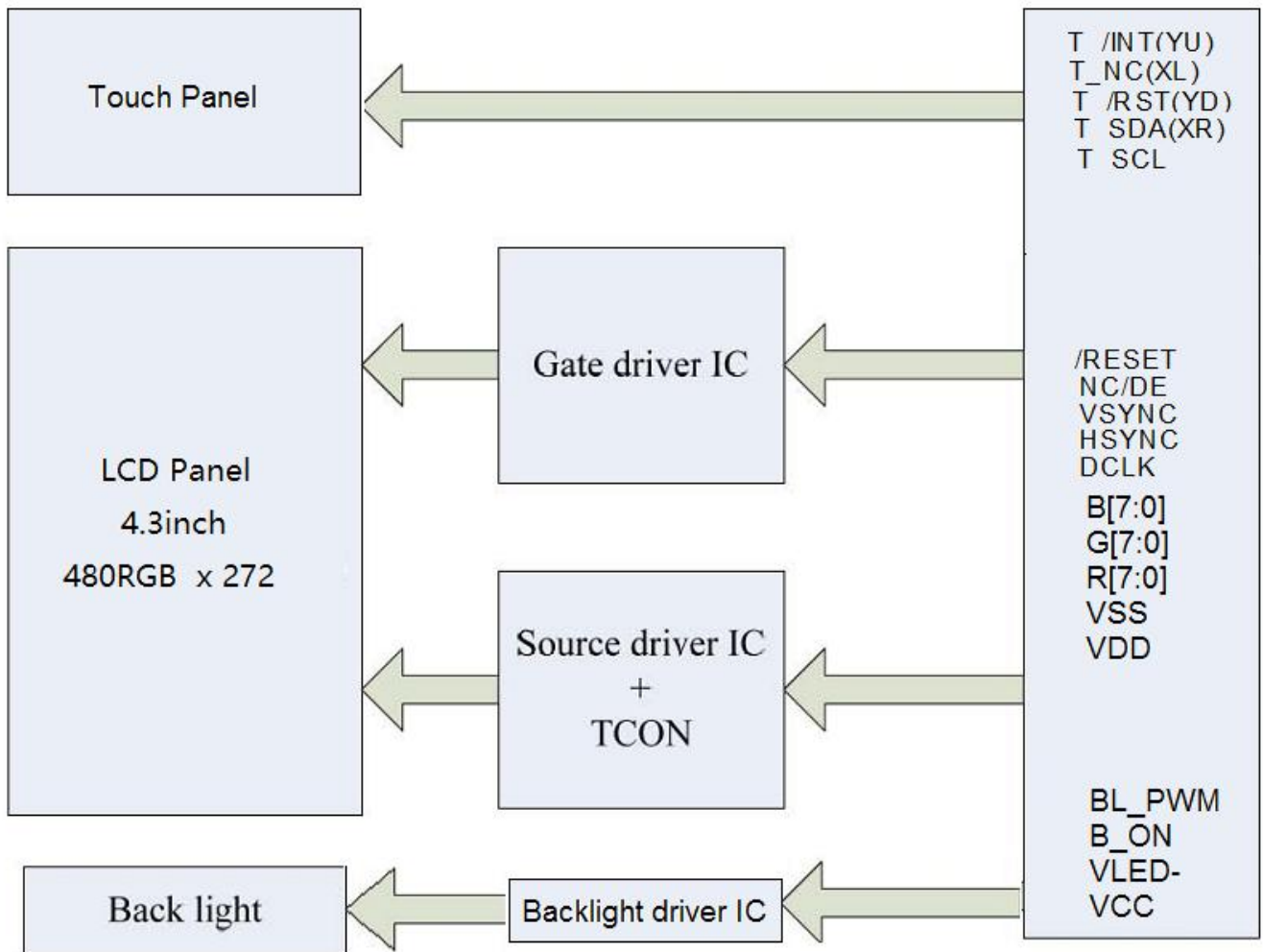

• TIMING CHARACTERISTICS

AC Characteristics

VDDI= 1.8V, VDD= 3.3V, AGND= 0V

Item	Symbol	Min.	Typ.	Max.	Unit	Conditions
System operation timing						
VDD power source slew time	TPOR	-	-	20	ms	From 0V to 99% VDD
GRB pulse width	tRSTW	10	50	-	us	R=10Kohm, C=1uF
Input/ Output timing						
CLK pulse duty	Tcw	40	50	60	%	
Hsync width	Thw	1	-	-	DCLK	
Hsync period	Th	55	60	65	us	
Vsync setup time	Tvst	12	-	-	ns	
Vsync hold time	Tvhd	12	-	-	ns	
Hsync setup time	Thst	12	-	-	ns	
Hsync hold time	Thhd	12	-	-	ns	
Data setup time	Tdsu	12	-	-	ns	
Data hold time	Tdhd	12	-	-	ns	
SD output stable time	Tst	-	-	12	us	Output settled within +20mV Loading = 6.8k+28.2pF.
GD output rise and fall time	Tgst	-	-	6	us	Output settled (5%~95%), Loading = 4.7k+29.8pF
3-wire serial communication						
Delay between CSB and Vsync	Tcv	1			us	
CS input setup time	Ts0	50			ns	
Serial data input setup time	Ts1	50			ns	
CS input hold time	Th0	50			ns	
Serial data input hold time	Th1	50			ns	
SCL pulse high width	Twh1	50			ns	
SCL pulse low width	Twl1	50			ns	
CS pulse high width	Tw2	400			ns	

AC Timing Diagram

Clock and Data Input Timing Diagram

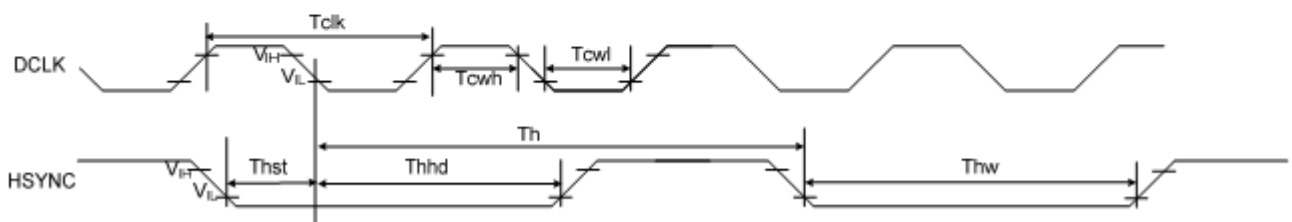
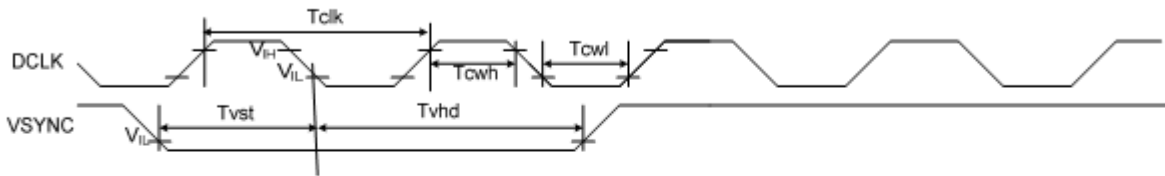

SYNC Mode

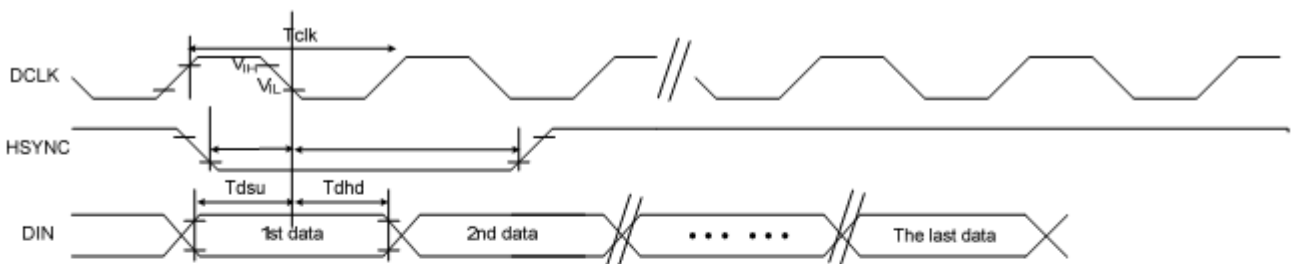

SYNC-DE Mode

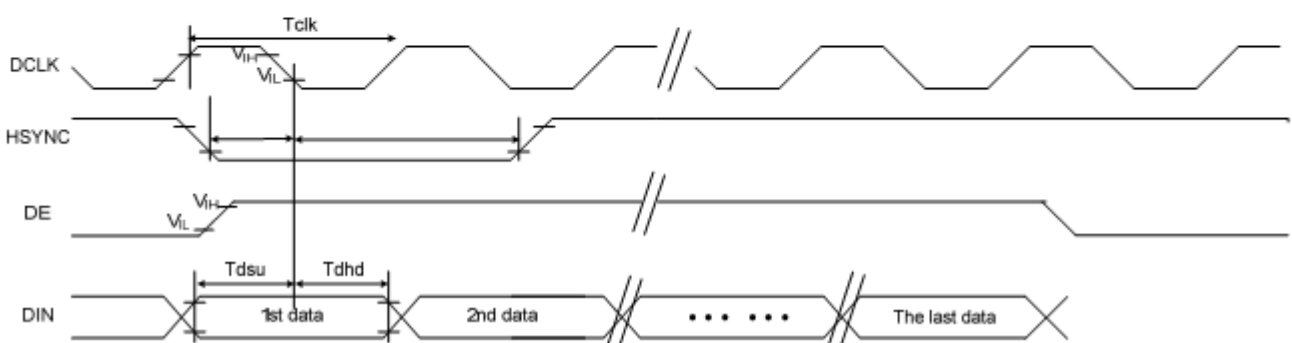

RGB Input Timing Table

Parallel 24-bit RGB Timing Table

Item	Symbol	Min.	Typ.	Max.	Unit	Remark	
DCLK Frequency	Fclk	9	12	15	MHz		
DCLK Period	Tclk	67	83	111	ns		
HSYNC	Period Time	Th	486	526	533	DCLK	
	Display Period	Thdisp		480		DCLK	
	Back Porch	Thbp	3	43	50	DCLK	By H_Blanking setting
	Front Porch	Thfp	2	2	2	DCLK	
	Pulse Width	Thw	1	1	1	DCLK	
VSYNC	Period Time	Tv	276	286	304	H	
	Display Period	Tvdisp		272		H	
	Back Porch	Tvbp	2	12	30	H	By V_Blanking setting
	Front Porch	Tvfp	1	1	1	H	
	Pulse Width	Tvw	1	1	1	H	

SYNC Mode Timing Diagram

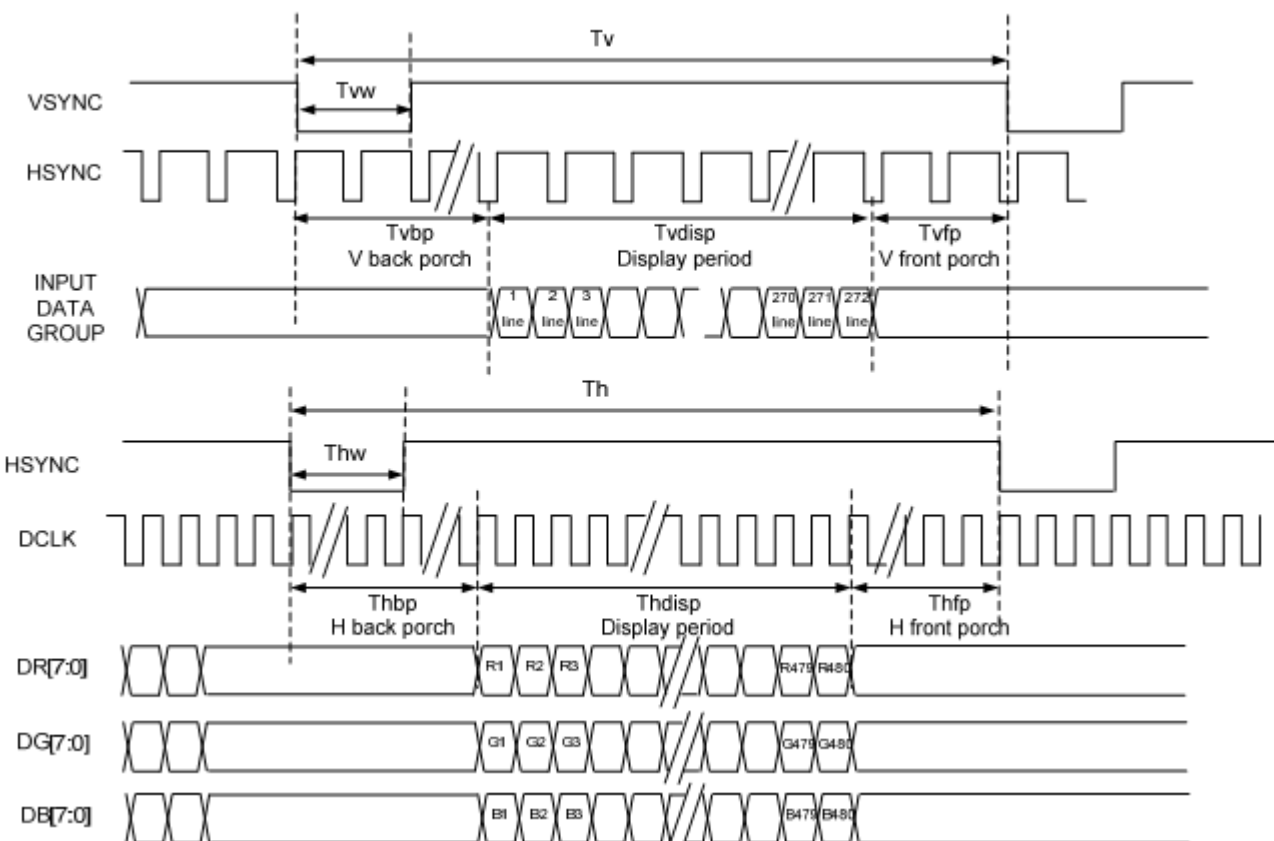

SYNC-DE Mode Timing Diagram

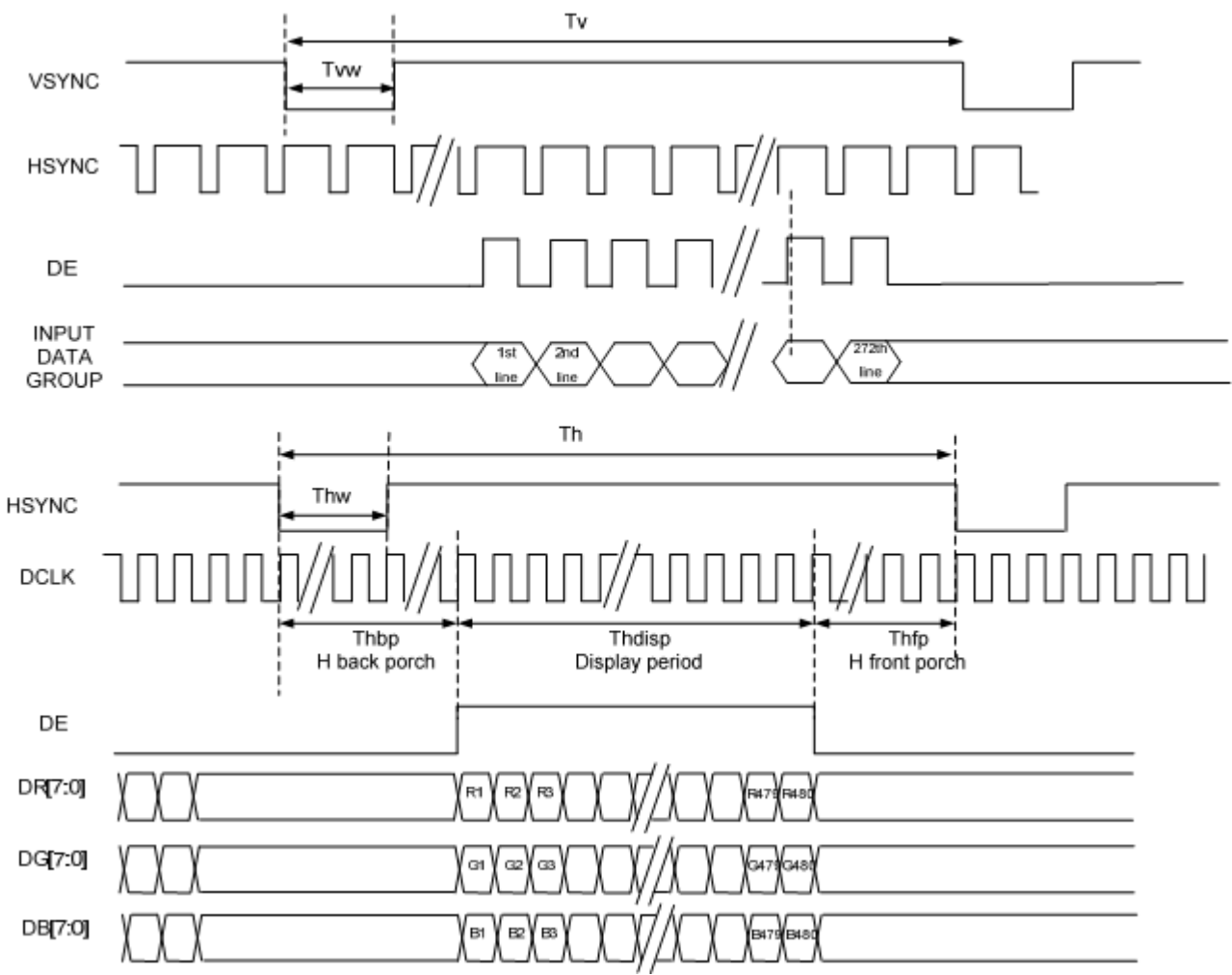

• **POWER ON/OFF SEQUENCE**

Power On Sequence

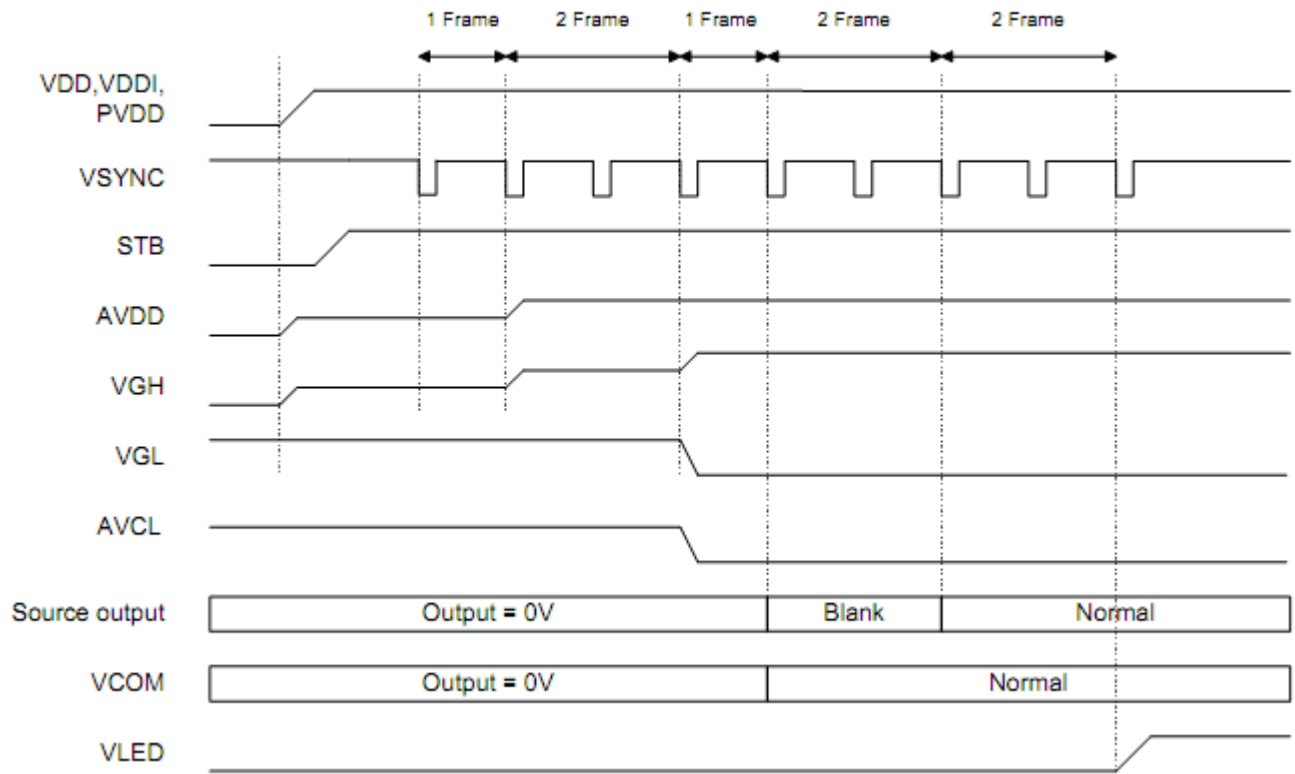

Power Off Sequence

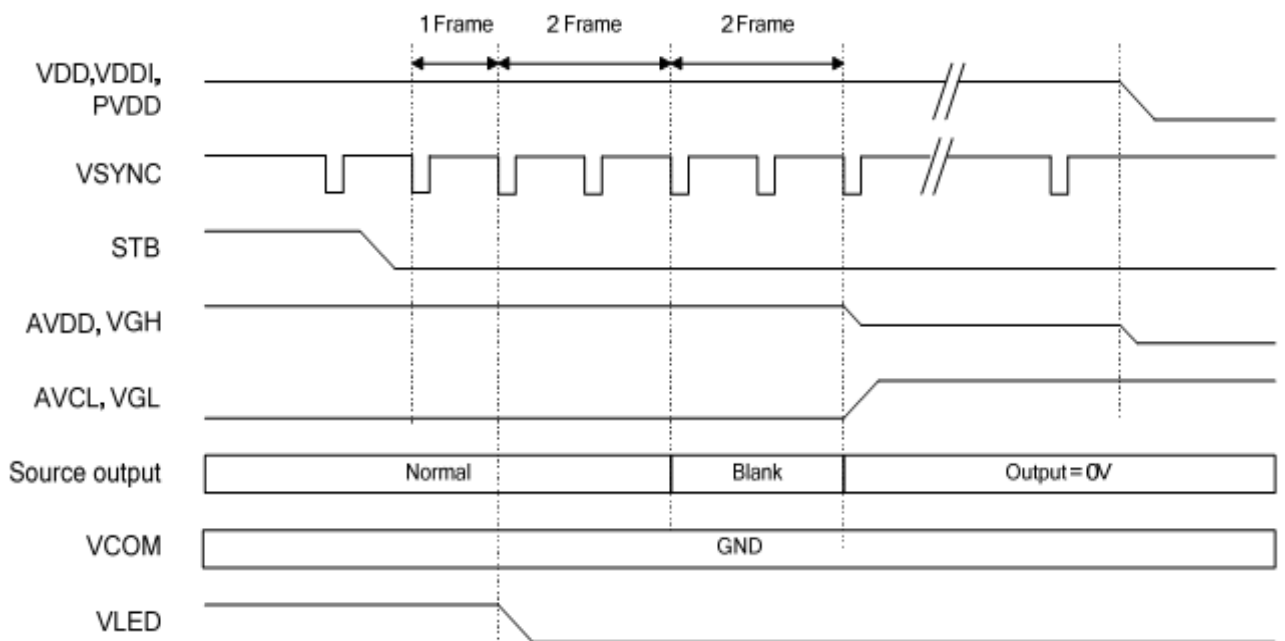

• TOUCH PANEL CHARACTERISTICS

Electrical Characteristic

Item	Min.	Typ.	Max.	Unit	Remark	
Linearity	-1.5%	---	1.5%	---	Each axis: X and Y	
Operating Voltage	---	5.0	10.0	V	DC	
Resistance	X axis:	480	---	1100	Ω	Film
	Y axis:	120	---	450	Ω	Glass
Chattering Time	---	---	10.0	ms		
Insulation Resistance	20	---	---	MΩ	@DC ≤10V	

Notes:

(a) Touch Panel Test Condition:

Typical is 23°C, 65%RH and 1013hPa. General can test the touch panel under 23°C±5°C, 45%-85%RH and 860hPa-1060hPa.

(b) Linearity Definition

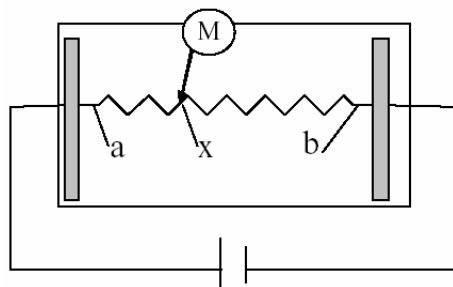

Va: maximum voltage in the active area of touch panel

Vb: minimum voltage in the active area of touch panel

X: random measuring point

Vxm: actual voltage of Lx point

Vxi: theoretical voltage of Lx point

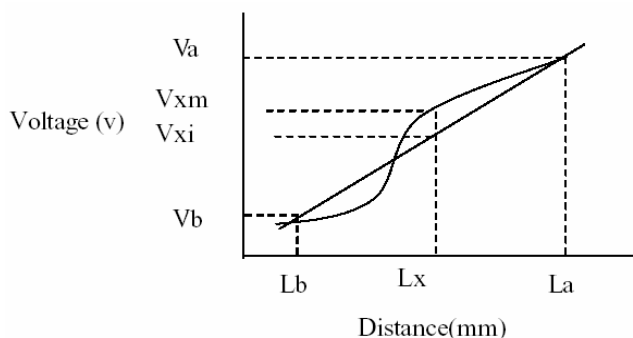

$$\text{Linearity} = \left[\frac{|V_{xi} - V_{xm}|}{(V_a - V_b)} \right] * 100\%$$

(c) Test area:

As follows and operation force is 180gf (single layer ITO Film), placental stylus is R0.8mm.

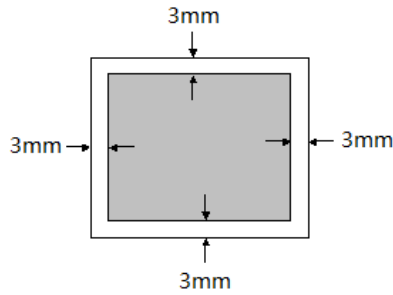

(d) Chattering measure definition (Condition: @ 3.0V, Frequency: 5HZ).

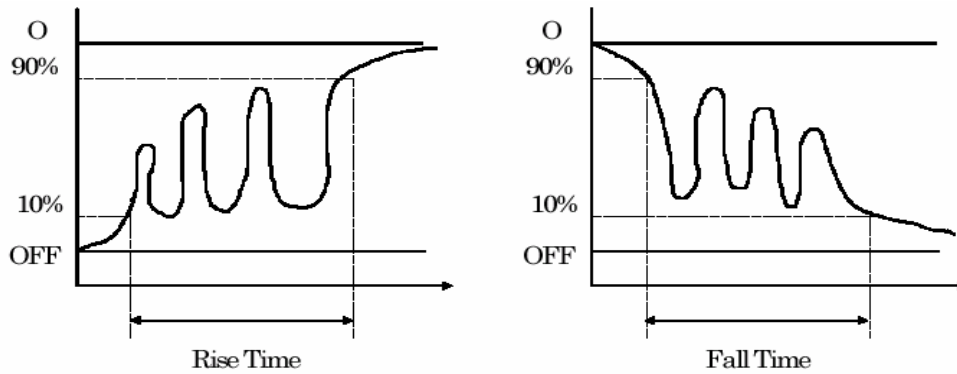

Mechanical Characteristic

Description	Specification	Remark
Activation force	100gf Max.	Test with Silicon pen. Hardness: SHORE A 30° Neb dirmeterϕ 12mm. Surface radian R12.5 mm
	100gf Max.	Test with Polyacetal pen. Neb dirmeterϕ 3.0 mm. Surface radian R0.8 mm
FPC Peeling Force	Min. : 600gf	Peeling upward by 90° , 3minutes
	Min. : 500gf	Peeling upward by 180° , 10minutes
Flexible pattern bending resistance	10 times at least.	Bending radius: R1.0 mm Bending times: 10 times

Notes:

(a) Activation force test condition:

1. Input DC 5V on X direction , Drop off Polyacetal Stylus(R0.8),until output voltage stabilize ,then get the activation force ;

- 2. R8 Silicon rubber for finger Activation force test ;
- 3. Test point : 9 points.

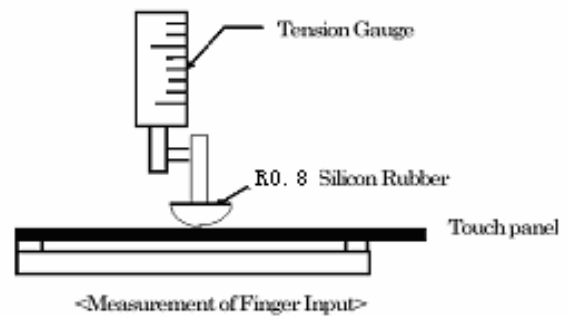
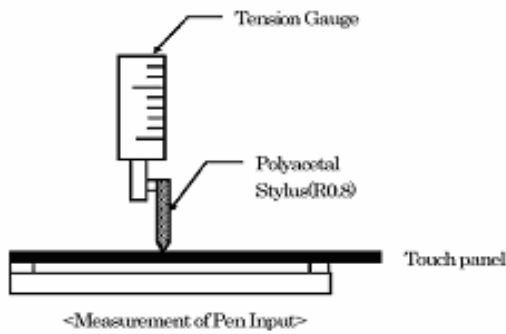

(b) Peeling upward by 90°, 500gf 3minutes

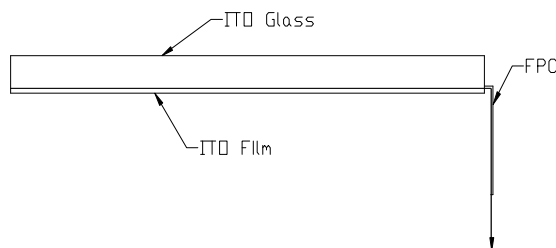

Peeling upward by 180°, 500gf 10minutes

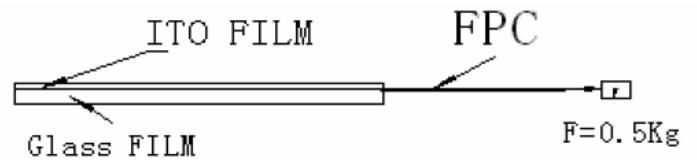

Optical Characteristic

Description	Specification	Remark
Transparency	75% (Min.)	JIS K-7105
Haze	7 % (Max)	JIS K-7105
Newton's Ring	N/A	40W natural color , 30cm distance at least,

Notes:

(a) Newton's Ring test condition:

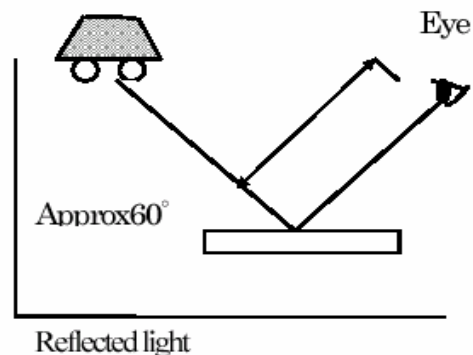
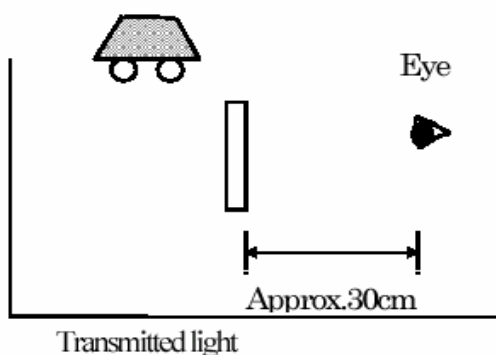

Durability Test

Under defined terms and condition test, product must be still satisfactory to electrical and mechanical characteristic.

Description	Specification	Remark
Pen sliding Durability	\geq 50,000 cycles	End shape:R0.8mm(Stylus) Load force: 250 gf Writing speed: 60 mm/sec Material of Pen: Polyacetal resin Sliding length: 30 mm Sliding location: Screen center Considered a one-way, return will be counted twice.
Hitting Durability	\geq 1 Million times	End shape: R0.8mm Hardness: 60° Load force: 250 gf Frequency: 2 Hz Material of Pen: Silicon rubber